



Akūt 22483-20

project name:

project location:

specifier name:

specifier location:

quantity:

fixture type:

modifications:

Base Specs

19.5"h x 8"w x 9"d
Opal Acrylic Internal Diffuser

Notes

Marine grade primer available — **±\$ Inquire.**

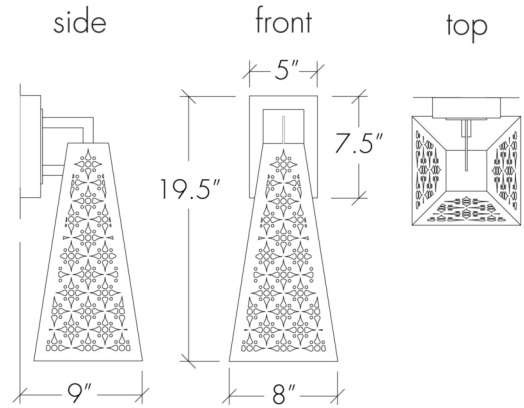



Akūt 22483-20

standard finish:

BA - Bronze Age
BK - Black
BP - Black Pearl
CB - Cast Bronze
CH - Chestnut
CR - Chrome
DI - Dark Iron
EB - Empire Bronze
MB - Medieval Bronze
NB - New Brass
SB - Smokey Brass
SP - Satin Pewter
SS - Smoked Silver

standard diffuser:

OA - Opal Acrylic

lampping:

02: 8.4w Integrated LED, 1181 Initial Lumens, 3000K, 90 CRI, 120V, Standard Phase Dimming (120V), or 120-277V, 0-10V Dimming (277V), UL/cUL Wet (120V Or 277V Must Be Specified)

03: Incandescent, 1 x E26 - 60W max ea, A-Type, 120V, Standard Phase Dimming, UL/cUL Dry/Damp

04: 8.4w Integrated LED, 1181 Initial Lumens, 3000K, 90 CRI, 120V-277V, 0-10V Dimming, UL/cUL Dry/Damp

10: Wattage Restriction Label - 1 x E26 for LED Retrofit 20W max ea - A-Type, 120V, Standard Phase Dimming, UL/cUL Dry/Damp

14: 8.4w Integrated LED, 1181 Initial Lumens, 3000K, 90 CRI, 120V, Standard Phase Dimming, UL/cUL Dry/Damp

