



# Akūt 22484-20

project name:

project location:

specifier name:

specifier location:

quantity:

fixture type:

modifications:

### Base Specs

19.5"h x 8"w x 9"d  
Opal Acrylic Internal Diffuser

### Notes

Marine grade primer available — **±\$ Inquire.**

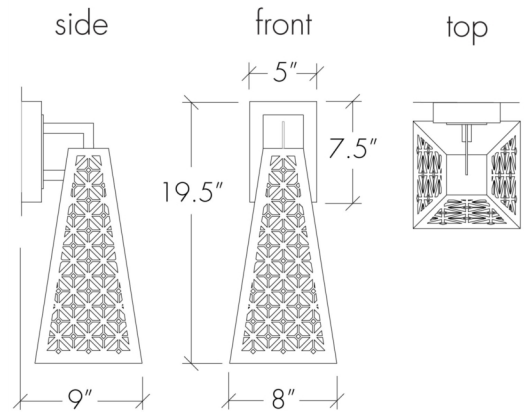



## Akūt 22484-20

### standard finish:

BA - Bronze Age  
BK - Black  
BP - Black Pearl  
CB - Cast Bronze  
CH - Chestnut  
CR - Chrome  
DI - Dark Iron  
EB - Empire Bronze  
MB - Medieval Bronze  
NB - New Brass  
SB - Smokey Brass  
SP - Satin Pewter  
SS - Smoked Silver

### standard diffuser:

OA - Opal Acrylic

### lampping:

**02:** 8.4w Integrated LED, 1181 Initial Lumens, 3000K, 90 CRI, 120V, Standard Phase Dimming (120V), or 120-277V, 0-10V Dimming (277V), UL/cUL Wet (120V Or 277V Must Be Specified)

**03:** Incandescent, 1 x E26 - 60W max ea, A-Type, 120V, Standard Phase Dimming, UL/cUL Dry/Damp

**04:** 8.4w Integrated LED, 1181 Initial Lumens, 3000K, 90 CRI, 120V-277V, 0-10V Dimming, UL/cUL Dry/Damp

**10:** Wattage Restriction Label - 1 x E26 for LED Retrofit 20W max ea - A-Type, 120V, Standard Phase Dimming, UL/cUL Dry/Damp

**14:** 8.4w Integrated LED, 1181 Initial Lumens, 3000K, 90 CRI, 120V, Standard Phase Dimming, UL/cUL Dry/Damp

