



Akūt 22494

project name:

project location:

specifier name:

specifier location:

quantity:

fixture type:

modifications:

Base Specs

25"h x 5"w x 7"d
Opal Acrylic Internal Diffuser

Notes

Marine grade primer available — **±\$ Inquire.**

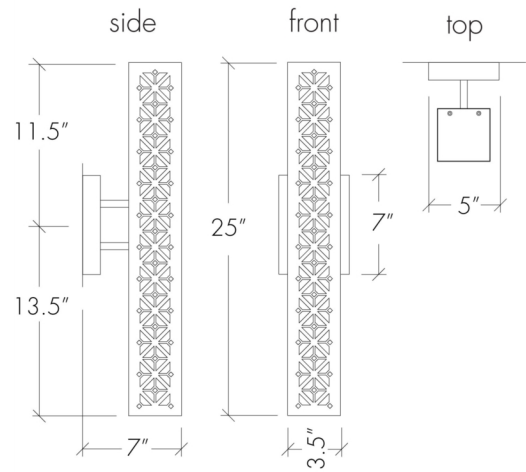



Akūt 22494

standard finish:

BA - Bronze Age
BK - Black
BP - Black Pearl
CB - Cast Bronze
CH - Chestnut
CR - Chrome
DI - Dark Iron
EB - Empire Bronze
MB - Medieval Bronze
NB - New Brass
SB - Smokey Brass
SP - Satin Pewter
SS - Smoked Silver

lampping:

02: 16.8w Integrated LED, 2362 Initial Lumens, 3000K, 90 CRI, 120V, Standard Phase Dimming (120V), or 120-277V, 0-10V Dimming (277V), UL/cUL Wet (120V Or 277V Must Be Specified)

04: 16.8w Integrated LED, 2362 Initial Lumens, 3000K, 90 CRI, 120V-277V, 0-10V Dimming, UL/cUL Dry/Damp

14: 16.8w Integrated LED, 2362 Initial Lumens, 3000K, 90 CRI, 120V, Standard Phase Dimming, UL/cUL Dry/Damp

standard diffuser:

OA - Opal Acrylic

